

Delta Part 1000 - Librum Superthermic Insulated Bi-Folding Door

Product Data Sheet
7 / 1

Product Description

The new generation of industrial doors are expressed by the Superthermic range of products. We have put into practice the experience built up over fifty years of design and manufacture, during which it has kept pace with the evolution of technology.

The production of large volumes of doors has always been marked by a high competence for customised solutions and the innovative design, especially appreciated by the architects as well as the end users.

Our business vision is based on employing cutting-edge technology for our products, certified by many exclusive patents, to provide solutions with added value for our customers.

Sustained by these solid roots, Enerco is the ideal partner for every architect, design engineer, building contractor or end user who is looking for door solutions that combine quality, functionality with high levels of aesthetics.

The Delta Part 1000 is one of the range of highly insulated bi-folding doors manufactured for extremely large openings in a variety of track arrangements. The maximum height of the door is 10m but can be manufactured to suit virtually any width of opening.

The Librum offers a proven individual door system solution where insulation, minimum headroom of only 150mm for doors up to 30sq/m and 300mm for doors above 30sq/m, high security and large openings are being considered.

All Enerco insulated bi-folding doors are manufactured in modular design and are almost maintenance free. This results in outstanding operational reliability, fast and inexpensive repairs when damage occurs, as well as low operating costs.

This is especially true of this door with its various patents and exclusive design. Providing high levels of insulation from its 55mm thick panels the Librum door is competitively priced to replace the conventional un-insulated steel folding shutter commonly used throughout the UK market.

The door can be fitted with complete all round safety controls i.e. photocells at low level and fail safe opto-electric safety edge.

Product Advantages

1. High insulation, 55mm thick CFC Polyurethane filled panels with thermal insulation value (for 25 m² surface without windows) of 1,53 W/m².°K
2. Can be manufactured to suit very large openings up to 10m high by virtually any width.
3. Aesthetically designed to complement the building structure
4. Opens to one side or bi-parting
5. Flexible track arrangements
6. Can be supplied manually or electrically operated to suit your budget and operation.
7. Emergency wicket doors or integrated personnel doors available.
8. Quick operational speeds offering full height opening immediately thus virtually eliminating the often high cost repairs associated with vertically rising doors.
9. Will operate normally in wind pressures of up to 140km/h BS EN 12424 Class 4
10. Full range of vision sections

Applications

- Large opening where conventional sectional doors and roller shutter are limited.
- Minimise draughts, improve insulation and maintain constant temperatures.
- As an external door where goods are despatched and received on a regular basis.
- As a partition between factory areas.
- Improves the working environment.
- Enhances aesthetic appearance.
- Exposed applications.
- Loading bay areas.



Door Design

The panels are manufactured from two skins of galvanised powder coated steel sheets encapsulating the robust internal steel frame sections that provide the door with its superior strength characteristics. Once assembled, the panels are injected with the CFC Polyurethane foam and assembled with the hinges, seals any additional items such as windows or mouldings.

The hinges are produced from galvanised steel, painted black, fitted with ball bearings and assembled to the load bearing frame by means of an adaptor plate and are concealed with the black rubber seal. (Patented system)

The extruded galvanised top track profile provides the guide and support for the panels and is equipped with the door leaf deflector assembly that transfer the leaves through 90° to their stored position.

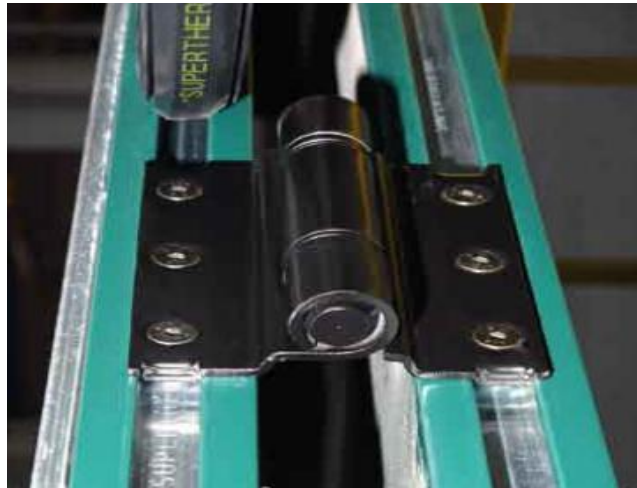
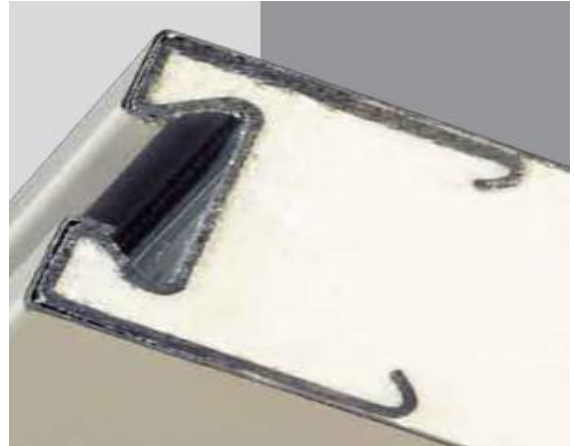

Fully adjustable roller trolleys are fitted with adjustable 20 mm dia. pins to ensure the door can cater for any uneven door levels.

Door Drive Mechanism and Control Panel

Either the door can be manually operated or supplied with an electric drive. Both drives can be either single action to one side or bi-parting. The electric drive is powered by either 415v 3PHNE or 240v single phase motor driving the traction chain system with manual override in the event of power failure. Proximity switches are used to limit the doors travel in either direction.

The heavy duty bottom floor track is manufactured of extruded galvanised steel and is fitted 120mm from the fixing face of the door. The top and bottom tracks support the weight of the door and enable the door to withstand the high wind pressures experienced. Ball bearing rollers supported by substantial 20mm diameter pins which are easy to adjust or change guide the door at the bottom.

Safety Features

As standard the door is supplied with dead man operation. As an option, safety equipment can be used to monitor the door threshold so that the door can be operated push to run. Safety equipment such as photocells and a safety edge can be added to the door. All safety features are self-diagnostic and fail-safe.

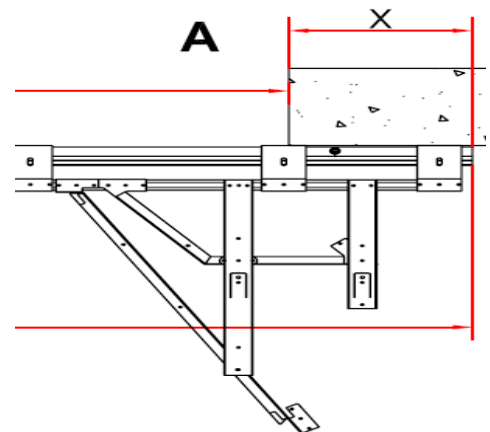

Windows

Can be inserted in every leaf of the door and the dimensions can be customised according to the size of the door leaves and the customer's requirements. The windows can be set in either black rubber EPDM frame with 130mm radius corners which makes it possible to insert safety glass up to 10 mm thick. Alternatively aluminium profiles with thermal breaks and 90° mitred corners can be used which allows for safety or double glazed glass up to 40 mm thick. Available in any geometric shape with standard size glazing as per the details below.

On request, special glass with "low U-values" can be fitted to ensure compliance with relevant building control requirements.







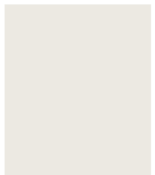

Dimensions

As standard the following window sizes are available in both the rubber and aluminium frames with transparent 8/9 safety glass,

530mm diameter, 700mm x 700mm, 500mm x 600mm, 700mm x 1000mm, 500mm x 800mm, 700mm x 1500mm, 580mm x 880mm & 700 x 2000 mm.



Standard Colours

							
White RAL 9002	Red RAL 3000	Brown RAL 8019	Grey RAL 7016	Blue RAL 5010	Green RAL 6005	Grey RAL 9006	Wooden color SL45

On request, powder coated finishes are available in other RAL colours.

The unique manufacturing process allows us to customise the aesthetics of the door with plain door leaves, vertical mouldings, rounded panes etc, please ask any of our team for advice.



Wicket Door

Wicket doors can be incorporated into the door leaf of the door with a minimal threshold. The door can be equipped with a panic bar or handle, cylinder and key.

Locking

The locking comprises of a black shoot bolt handle with galvanised steel bars which when activated protrude into the locks in the top and bottom position.

Remote Controls

The door can be supplied with additional remote controls. These fall into two categories, activation and safety. When wired to activate, they will open the door from its closed position, stop the door from closing when open and stop / reverse the door when closing. When wired to safety the features are the same as to activate however the door will not open when closed.



Remote controls include induction loops, photocells, radar, push buttons / pull switch operation or radio / infrared controls.

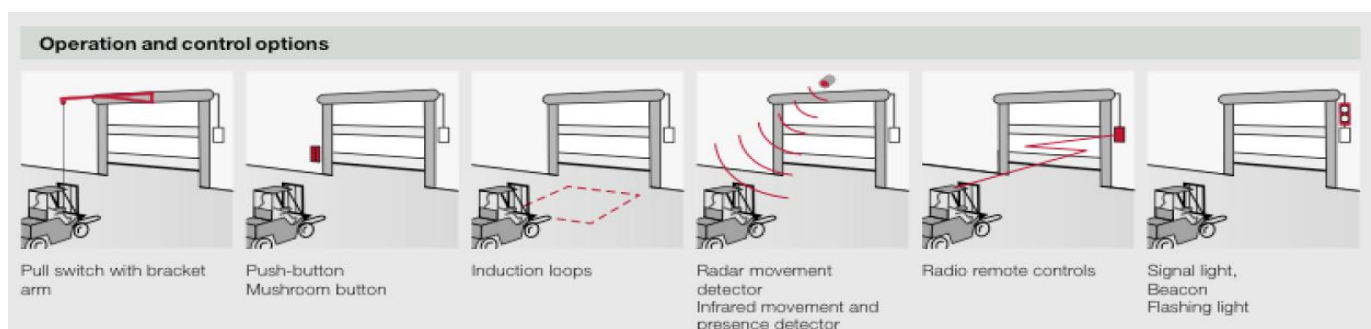



Technical Data

Application	Internal	Yes
	External	Yes
CE Marked	Manufacturers Declaration of Conformity	Compliant
Mechanical compliance	BS EN12604	Compliant
Safe Use of Power Operated Doors	BS EN12453	Compliant
Safety equipment	DIN EN13241 – 1	Compliant
Resistance against wind pressure	DIN EN12424	Class 4
Sound Insulation		22dB
Door sizes	Width max. mm (20 + 20 leaves, 1200mm/panel)	50000
	Height max. mm (55mm panel)	6000
	(65mm panel)	8000
	(80mm panel)	10000
Space requirement for fitting	Subject to size	
	Headroom internally mounted up to 30sq/m	150
	Headroom internally mounted above 30sq/m	300
	Headroom externally mounted	730
Control Panel Style & Size	Controls in plastic casing (W x H x D) cm	20 x 40 x 20 included
Door construction	Self supporting	Modular
Curtain / Door leaf	55mm thick insulated panels	Included
Track Material	Galvanised steel	Included
	Powder coated RAL choose colour	Optional
	Polished stainless steel	N/A
Lintel Cover	Standard	Optional
	Sloped 30°	Optional
Operator and controls	Manual operation	Standard
	Electric operation	Optional
	Supply voltage	1PHNE or 3PHNE
	Open-Stop-Close Buttons	Optional
	Emergency Stop	Optional
	Fuse rating if electrically operated	16amp slow acting
	Protection category	IP54
	Safety protection	Optional
	Photocell	Optional
	Safety edge	Optional
	Timed closing	Optional
	Electronic limits	Included
Emergency Opening	Manual change over if electric	Included
Activators	Induction loop	Optional
	Photocells	Optional
	Pull cords	Optional
	Radar	Optional
	Radio control	Optional
	Traffic lights	Optional
	Flashing beacon	Optional
	Audible alarm	Optional
Accessories	Protection barriers / Bollards	Optional

Warranty

The door is supplied with a 24 month parts and labour warranty as standard providing the equipment is serviced by an Enerco trained fully qualified high speed door engineer in accordance with the service intervals detailed below. To satisfy the requirements of the warranty, an agreement must be signed and dated within 30 days of the installation date. Failure to service the product in accordance with the service schedule or by unqualified engineers will result in the warranty being null and void.

Servicing

To help protect your investment and extend the effective working life of the equipment, full maintenance packages are available and, in most cases, we can maintain all of your existing doors and loading bay equipment. The door must be serviced at least once per annum or every 25,000 cycles whichever is applicable. Full details of our preventative maintenance packages are available on request. Enerco recommend the first service is carried out 6 months after installation to ensure the number of cycles can be monitored.

We have Safe Contractor, CHAS and Construction Line accreditation as well as being active members of the Doors and Hardware Federation (DHF) where we have their seal of approval for the service and maintenance of doors. We ensure that our staff are trained to the highest standard and all have an NVQ qualification in line with current industry guidelines This NVQ is in addition to the CSCS Health and Safety, First Aid, Asbestos Awareness and other training including product training applicable to our industry and is continually being updated.





Other products in the Delta range from Enerco include: -

- Delta Guard – Commercial Shutters
- Delta Roll – Steel Roller Shutter Doors
- Delta Check – Fire Roller Shutter
- Delta Secure – High Speed Security Doors
- Delta Slide – Insulated Overhead Doors
- Delta Insudoor – Insulated Roller Shutters
- Delta Part – Insulated Bi – Parting Doors
- Delta Strip – Strip Curtains
- Delta Steel – Steel Security Door Sets
- Delta Fold – Steel Sliding Folding Shutters
- Delta Level – Dock Levellers
- Delta Lift – Scissor Lifts
- Delta Seal – Dock Sealing Systems
- Delta Shield – Perimeter Security
- Delta Bar – Window Bars
- Delta Grille – Retractable Window Grilles
- Delta Service – Service and Repairs
- Delta Load – Loading Bay Accessories
- Delta Glide – Garage Doors
- Delta Aluglaze – Aluminium Glazed Systems
- Delta Crash – Crash Door Systems

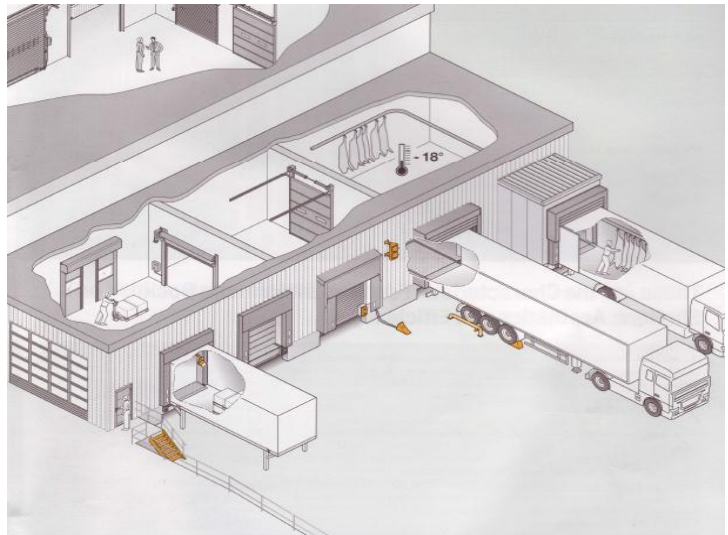

Please contact our sales team for more information on 01525 289322 or a brochure. Alternatively visit our web site www.enerco.co.uk or our dedicated high speed door web site www.enercohighspeeddoors.co.uk .

We reserve the right to change the product data sheets and specification without prior notification